

**FLEXA<sup>®</sup>**

Improving Children's Lives since 1972

<b>Improving Children's Lives</b>	<b>3</b>
<b>FLEXA Grow Green</b>	<b>5</b>
<b>FLEXA Concepts</b>	<b>7</b>
<b>FLEXA Insight</b>	<b>8</b>
<b>FLEXA Sleep</b>	<b>9</b>
<b>The FLEXA Bed System</b>	<b>13</b>
<b>FLEXA Bed Guide</b>	<b>15</b>
<b>The Collections:</b>	
<i>Mattresses, Duvets &amp; Pillows</i>	17
<i>Baby</i>	21
<i>Classic</i>	25
<i>Popsicle</i>	35
<i>Dots</i>	41
<i>White</i>	45
<i>Nor</i>	51
<i>Roomie</i>	59
<i>Freja</i>	65
<i>Cottage</i>	69
<i>Textile</i>	73
<b>FLEXA Play</b>	<b>77</b>
<b>FLEXA Study</b>	<b>89</b>



# Improving Children's Lives

At FLEXA we bring joy to families around the world with our furniture, textiles, and toys, all designed to improve your child's life.

## Our mission is to:

- ◆ Provide children with better Sleep
- ◆ Develop children through Play
- ◆ Support children when they Study

Our products are designed in Denmark and incorporate the highest standards of safety and quality. They are made from long-lasting, environmentally friendly materials and are purposely designed to grow with children as their needs change.

## FLEXA SINCE 1972

The very first FLEXA bed was crafted by hand in 1972. Like some of our furniture today, the bed was made from natural Scandinavian pinewood. The name "FLEXA" was chosen to illustrate the flexibility of the design, as the bed could be reconfigured to suit a child's changing needs.

Today, parents all over the world can shop at FLEXA, for solutions in Sleep, Play and Study, for their babies, toddlers, children, and tweens – both online and in their local FLEXA shop.





# Environmental Sustainability Programme

## — FLEXA Grow Green

*These are the first initiatives on our journey to achieving CO<sup>2</sup> neutrality.*

### **Certified Wood**

We value the environment and use FSC™ and PEFC™ certified wood in our production.

### **Recycling Timber**

We recycle all waste wood in our production and use leftover sawdust to heat our factories.

### **Sustainable Surface Treatments**

We only use safe and healthy surface treatments.

### **Recycled Cardboard**

We strive to use only recycled package material.

### **Green Energy**

Since 2022 we only use green energy in our own factories.

### **Reducing Our Plastic Footprint**

We are outphasing plastics parts and packaging material.

### **Supply Chain Sustainability**

Our products are packaged to optimise transport in order to ensure a low impact on the environment.



# Sleep, Play, Study

## Introduction

*Children's development is dear to us, and we want to help ensure a healthy and natural development for children all over the world.*

That's why all FLEXA products are purposely designed to grow with children as their needs change, provide them with better sleep, develop them through play, and ensure them the best conditions for studying.

To create a safe and stimulating environment for children and support a balanced development, the FLEXA Sleep collection helps children to UNWIND, RECHARGE, and DREAM. The FLEXA Play collection encourages children to MOVE, CREATE, IMAGINE, and EXPLORE, and the FLEXA Study collection allows children to TRY, LEARN, and GROW.

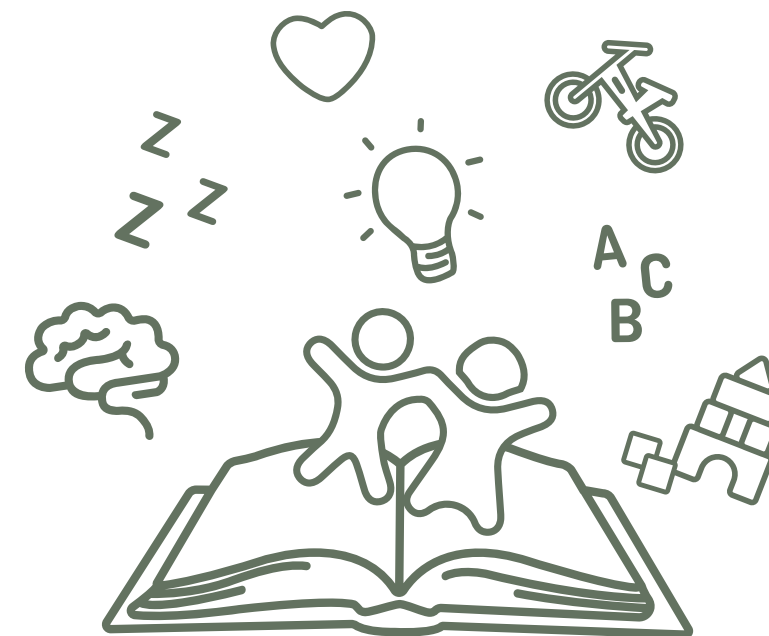

# FLEXA Insight

FLEXA Insight is an online parenting platform where parents from all over the world can get inspired by valuable insights, tips, and new ideas from our passionate, Danish team of experts in children's development.

Our group of experts has researched children's development from almost every angle. One expert is an experienced family advisor who has met hundreds of Danish families. Another expert has dedicated his entire life to researching children's well-being and development through play. And some of the other experts specialise in children's motor skills, sensory integration, and learning.

Together, they will inspire parents to provide children with better Sleep, develop them through Play, and support them when they Study.





# FLEXA Sleep

## — *Creating Childhood Dreams*

Well-rested children are healthier and happier, and quality sleep boosts their ability to focus and learn, handle challenges, and thrive in childhood. That's why we strive to give every child of any age the best possible conditions for a great night's sleep.

We do this by developing and designing a full collection of beds, mattresses, duvets, and pillows that fit the different needs of growing children. All our products are created with great attention to detail, using only long-lasting, quality materials that are free from any harmful substances to make sure we provide the very best framework for a safe and healthy sleeping environment.

The FLEXA Sleep collection helps children to UNWIND, RECHARGE, and DREAM.

### **Why FLEXA Sleep**

- ◆ Flexible bed systems and space-saving solutions
- ◆ Optimal comfort and ergonomic support for growing children
- ◆ Modern Scandinavian design and calming colour schemes
- ◆ Meets EU's strictest safety and quality requirements
- ◆ Designed in Denmark







Every FLEXA Sleep product is especially developed and designed to help children UNWIND, RECHARGE, and DREAM.

## UNWIND

Encouraging children to slow down before bedtime

Unwinding takes time after a long day, and even the busiest, little explorers will need some quiet downtime and a chance to pause and relax without any tasks or expectations.

Helping your child feel calm, stay stress free, and fall asleep faster.

## RECHARGE

Helping children process all the impressions of the day

Quality sleep is essential for children's development and one of the brain's most important building blocks. After a great night of slumber, the little sleepyheads will be ready to explore the world, play, and learn new things.

Allowing your child's body and mind to recharge.

## DREAM

Giving children the best conditions for a peaceful night's sleep

Encouraging healthy sleeping habits and providing a safe and comfortable space of their own where little ones can snuggle up and feel free to go on adventures – both in their dreams and during the day.

Helping your child grow, physically and mentally.



# Because Children Grow

*The FLEXA Bed System*

*From toddler to tween...*

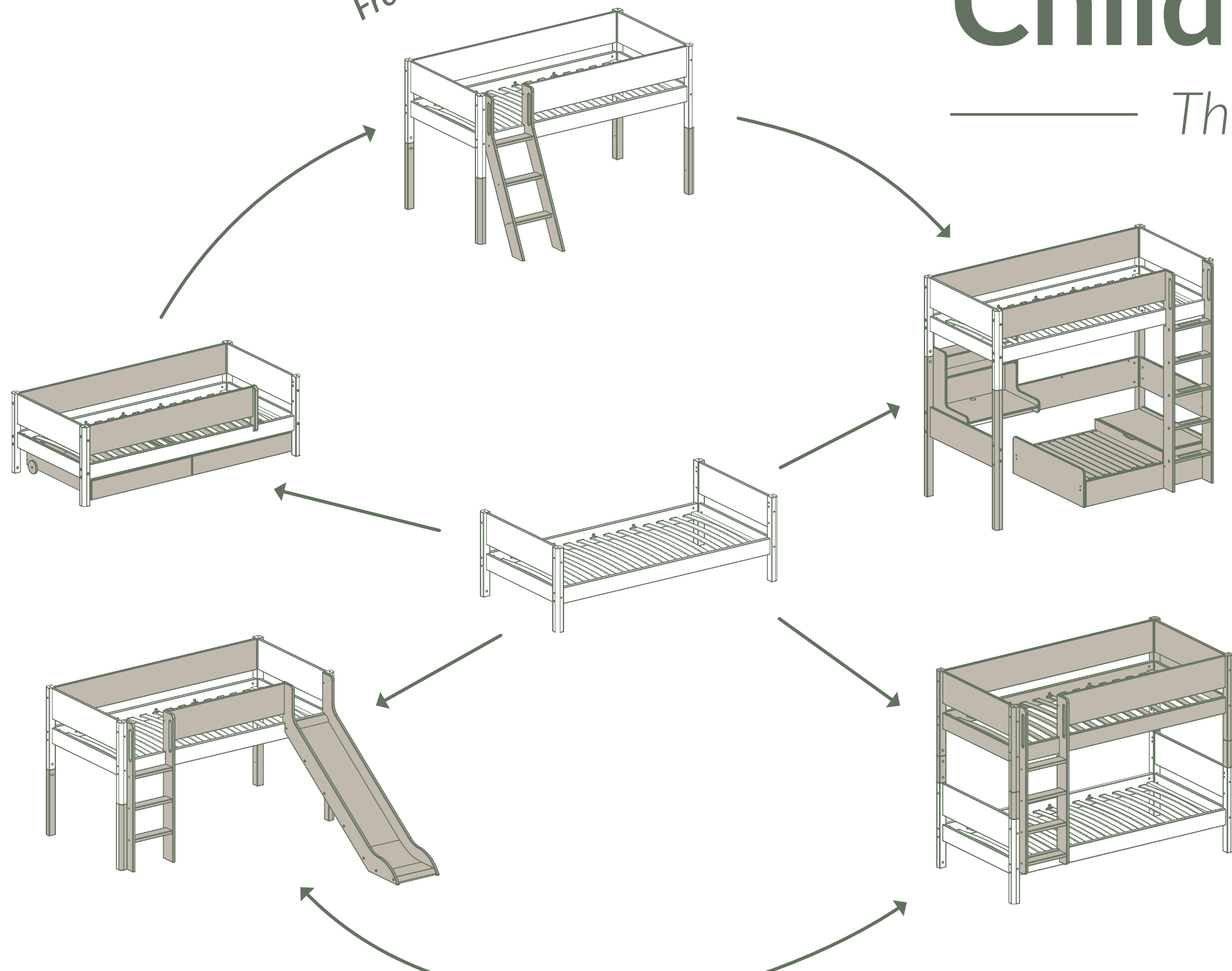

*...and expanding families*

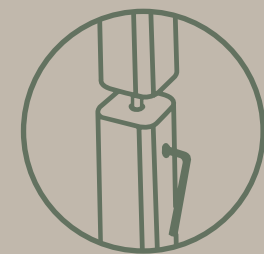

You can easily rebuild the bed to fit the changing needs of your growing child

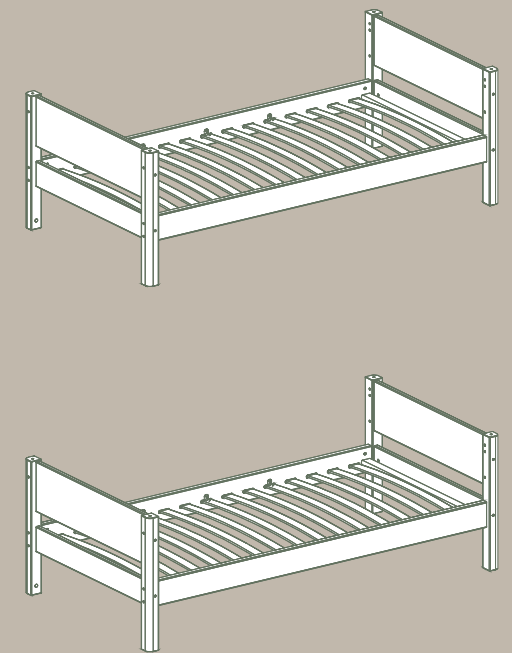

# FLEXA

# Bed Guide

— Growing Together

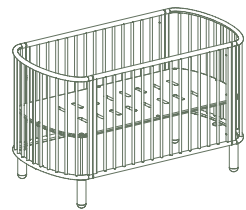

### Baby Cots

At FLEXA we recommend a cot from when the child is born up until the age of 3 where a junior bed or a single bed can be used.

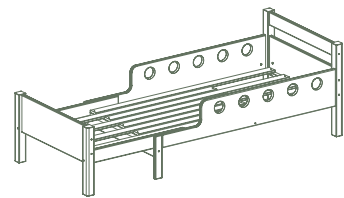

### Junior Beds

A junior bed is a great transitional bed for toddlers since it is a smaller version of a single bed. The junior beds are both easy and safe for children to crawl in and out of and they will love the feeling of having more space to move around.

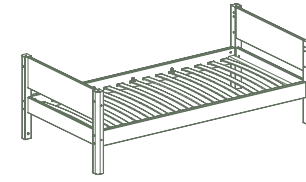

### Low Beds

From the age of 3 a single bed can be chosen. Most children will love having a big bed like their parents that offers many new opportunities for play and fun. Safety rails can be added when the child is still little and then be removed when no longer needed.

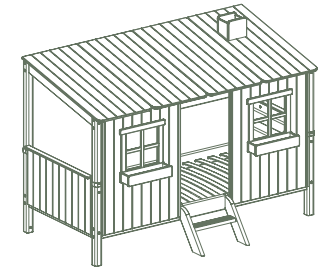

### House Beds

A house bed is great for children from the age of 3 who want to add some extra playfulness to their room. Let your child sleep in their own little house and provide them with a safe, private, and fun space.

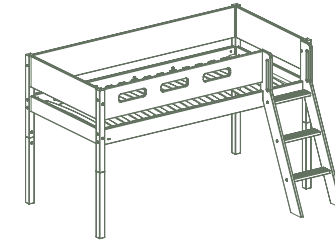

### Mid-High Beds

FLEXA mid-high beds are lifted from the ground and are a good middle way between a single bed and a high bed. Perfect for active children from the age of 6 and up.

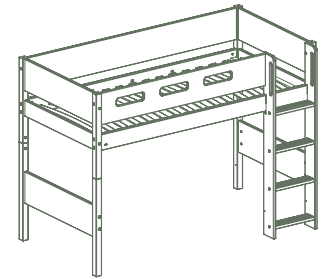

### Semi-High Beds

The semi-high beds are slightly taller than the mid-highs and lower than the high beds. We recommend the semi-high beds from the age of 6.

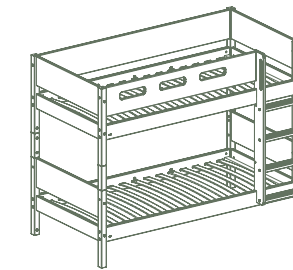

### Bunk Beds

A bunk bed is perfect for shared rooms. Smaller children from the age of 3 can sleep in the lower bunk with a safety rail and their bigger siblings from the age of 8 can sleep in the top bunk.

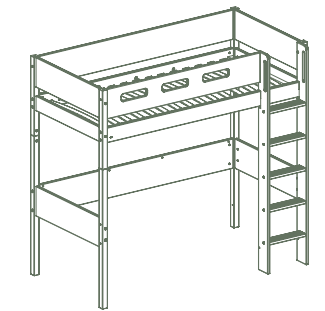

### High Beds

As children get older their needs change. From the age of 8 they will be spending way more time playing outside the bed than in it and therefore a high bed can be recommended. FLEXA high beds are 180 cm tall making space for storage, a desk or a play area underneath.

# Find the Right Mattress



## The FLEXA Matress

A mattress with 3 cm latex with cool gel on one side, 5 cm cold foam in the middle, and 4 cm latex on the other side. Latex with air ducts provides good ventilation and transports moisture away from the body. The mattress is reversible to secure the right support for the growing child. Start by using the side with the 3 cm of latex. When the child reaches 40 kg, it's time to turn the mattress.

Suitable for children with sensitive skin or allergies.



## FLEXA Latex

A mattress with 6 cm latex and 6 cm cold foam on each side. Latex with air ducts provides good ventilation and transports moisture away from the body. The mattress adapts to the child's body, and it has a water-repellent, non-woven inner cover.

Suitable for children with sensitive skin or allergies.



## FLEXA Foam

A mattress with 12 cm premium foam and a zone landscape that adjusts to the movements of the child. The foam mattress has good ventilation which prevents the child from overheating. It has a non-woven, antibacterial and water-repellent inner cover.



## FLEXA Spring

A mattress that consists of 218 springs per m<sup>2</sup>. Surrounded by 3 cm soft flexible cold foam to ensure increased comfort for the child. The mattress has good ventilation which prevents the child from overheating. It has a water-repellent, non-woven inner cover.

Provides the right support for children over 50 kg.

# ...and the Right Cover



## Cotton Cover

Perfect for most children. The cover has a soft surface, and it's made of 100% natural materials for reinforced breathability that can help regulate the child's body temperature throughout the night.



## Bamboo Cover

Perfect for children with sensitive skin or allergies. The cover has a silky soft surface, and the fabric has antibacterial properties, which helps create a nice, hygienic sleeping environment.



## Eucalyptus Cover

Perfect for children who tend to sleep hot. The cover has a cooling effect and can help transport heat away from the body and absorb moisture, ensuring that the sleeping environment stays dry and comfortable.



**FLEXA** - Latex/Foam/Latex Mattress

	LENGTH 200 CM	LENGTH 190 CM
Cotton Cover	83-10425 L: 200 W: 90 H: 12	83-10439 L: 190 W: 90 H: 12
	83-10442 L: 200 W: 120 H: 12	-
	83-10448 L: 200 W: 140 H: 12	83-10467 L: 190 W: 140 H: 12
Bamboo Cover	83-10426 L: 200 W: 90 H: 12	83-10440 L: 190 W: 90 H: 12
	83-10443 L: 200 W: 120 H: 12	-
	83-10449 L: 200 W: 140 H: 12	83-10446 L: 190 W: 140 H: 12
Eucalyptus Cover	83-10427 L: 200 W: 90 H: 12	83-10441 L: 190 W: 90 H: 12
	83-10444 L: 200 W: 120 H: 12	-
	83-10450 L: 200 W: 140 H: 12	83-10447 L: 190 W: 140 H: 12

**Latex** - Latex/Foam Mattress

	LENGTH 200 CM	LENGTH 190 CM
Cotton Cover	83-10419 L: 200 W: 90 H: 12	83-10458 L: 190 W: 90 H: 12
	-	-
	83-10464 L: 200 W: 140 H: 12	83-10467 L: 190 W: 140 H: 12
Bamboo Cover	83-10420 L: 200 W: 90 H: 12	83-10459 L: 190 W: 90 H: 12
	-	-
	83-10465 L: 200 W: 140 H: 12	83-10468 L: 190 W: 140 H: 12
Eucalyptus Cover	83-10421 L: 200 W: 90 H: 12	83-10460 L: 190 W: 90 H: 12
	-	-
	83-10464 L: 200 W: 140 H: 12	83-10469 L: 190 W: 140 H: 12





**Foam** - Foam Mattress Ribbed Core

	LENGTH 200 CM	LENGTH 190 CM
Cotton Cover	83-10416 L: 200 W: 90 H: 12	83-10452 L: 190 W: 90 H: 12
	-	-
	-	-
Bamboo Cover	83-10417 L: 200 W: 90 H: 12	83-10453 L: 190 W: 90 H: 12
	-	-
	-	-
Eucalyptus Cover	83-10418 L: 200 W: 90 H: 12	83-10454 L: 190 W: 90 H: 12
	-	-
	-	-

**Spring** - Spring Mattress Pocket Soft Foam

	LENGTH 200 CM	LENGTH 190 CM
Cotton Cover	83-10422 L: 200 W: 90 H: 12	83-10470 L: 190 W: 90 H: 12
	83-10473 L: 200 W: 120 H: 12	-
	83-10476 L: 200 W: 140 H: 12	83-10479 L: 190 W: 140 H: 12
Bamboo Cover	83-10423 L: 200 W: 90 H: 12	83-10471 L: 190 W: 90 H: 12
	83-10474 L: 200 W: 120 H: 12	-
	83-10477 L: 200 W: 140 H: 12	83-10480 L: 190 W: 140 H: 12
Eucalyptus Cover	83-10424 L: 200 W: 90 H: 12	83-10472 L: 190 W: 90 H: 12
	83-10475 L: 200 W: 120 H: 12	-
	83-10478 L: 200 W: 140 H: 12	83-10481 L: 190 W: 140 H: 12

**Other**

				
<b>Baby Mattress Oval Shaped</b> 83-10335 L: 140 W: 70 H: 8	<b>Sheet, oval Shaped w. elastic band - White</b> 83-70332 L: 140 W: 70	<b>Foam mattress, Polyether foam - Polyester cover</b> 83-10378 L: 120 W: 60 H: 8	<b>Foam mattress set Extens. bed - Cream cover</b> 83-10380 L: 140 W: 70 H: 8 L: 50 W: 70 H: 8	<b>Foam mattress Ribbed core - Cotton cover</b> 83-10451 L: 180 W: 90 H: 12



# Children's Duvets & Pillows

*Our duvets and pillows are designed to provide the best possible sleep for growing children by ensuring optimal temperature and comfort all night long.*

The down filling is soft, airy, and flexible so children can mould, hug, or snuggle into the duvets and pillows just the way they like it.

All our duvets and pillows are OEKO-TEX® certified, made using natural, quality materials that are free from any harmful substances to make sure we provide the very best framework for a safe and healthy sleeping environment for children.

**Duvets** - Duck down fill 90/10

**Pillows** - 100% Duck down fill

				
83-70435 L: 200 W: 140	83-70436 L: 140 W: 100	83-70437 L: 65 W: 60	83-70438 L: 70 W: 50	83-70439 L: 45 W: 40

# The Baby Collection

— *Making Memories*

Complete collection of essentials for babies and small children  
Cots, highchair, changing table, accessories, and textiles in caring designs  
and safe materials. To give baby the best start in life.

## **Why FLEXA Baby**

- ◆ Functional furniture that grows with the child
- ◆ Scandinavian design and craftsmanship
- ◆ Meets EU's strictest quality and safety requirements
- ◆ Strong, long-lasting materials
- ◆ Designed in Denmark

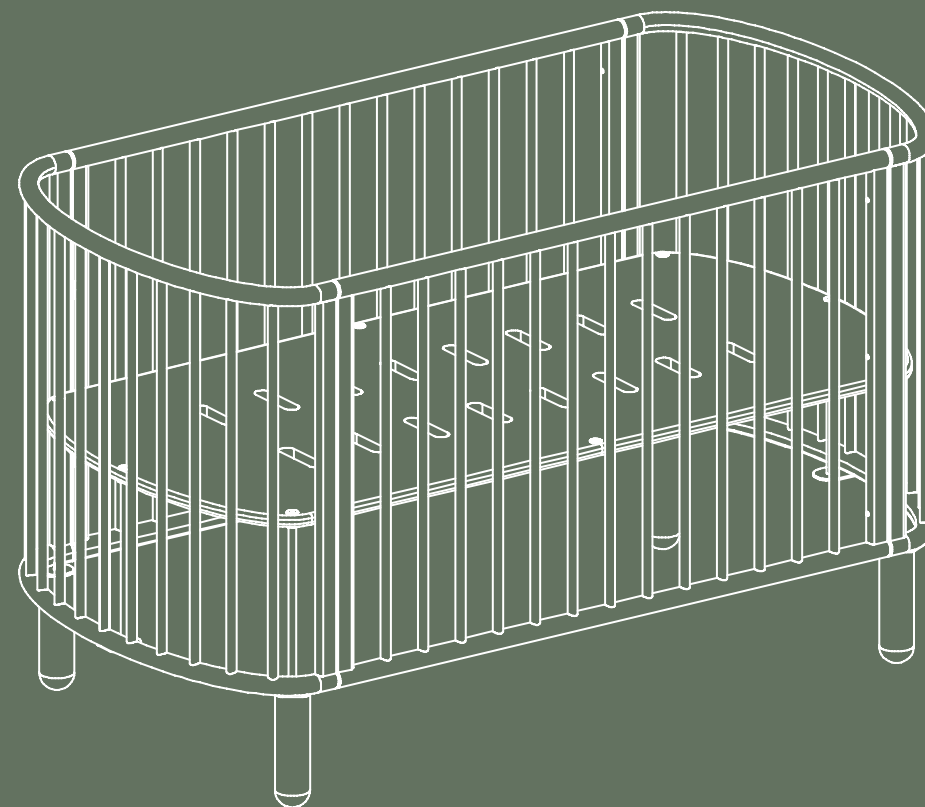



**Beds & Bed Accessories**

COLOUR OPTIONS



80-17801-40  
80-17801-95  
H:88 W:75 L:145



80-19802-40  
H:92 W:64 L:124



83-10335  
H:8 W:70 L:140

Fits H.S. Baby Cot



83-10378  
H:8 W:70 L:140

Fits Dois Baby Cot



83-70332  
L:140 W:70

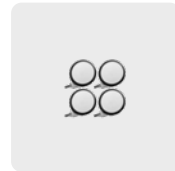

82-60020  
H: 8 Ø:7,5

**High Chair**

COLOUR OPTIONS



82-10074-40  
82-10074-1  
H:83 W:61 D:51



82-10075-40  
82-10075-1  
H:83 W:61 D:51



82-10076-40  
82-10076-1  
H:83 W:61 D:51



82-10079-40  
82-10079-1  
H:73 W:58 D:46



82-10026-40  
82-10026-1  
L:36,5



82-10023-40  
82-10023-1  
W:39 D:12



82-10024-2  
W:39 D:26

**Changing Units**

COLOUR OPTIONS  
KNOBS



90-11164-40  
90-11164-518  
90-11164-519  
90-11164-523  
90-11164-524  
90-11164-95  
W:72 H:97 D:44



90-11165-40  
90-11165-518  
90-11165-519  
90-11165-523  
90-11165-524  
90-11165-95  
W:72 H:97 D:44



90-11163-40  
W:72 H:97 D:44



H:10 W:6  
82-60021-40





# The Classic Collection

— *Endless Possibilities*

Providing a flexible system designed to grow with the child. Beds, space-saving storage units, desks, and accessories in a clean and natural design. Endless possibilities.

## Why FLEXA Classic

- ◆ Flexible system designed to grow with the changing needs of every child
- ◆ Rounded edges for comfort and safety
- ◆ Mix & match bed, storage, and desk for a full room interior
- ◆ Made from PEFC™ certified wood
- ◆ Designed in Denmark

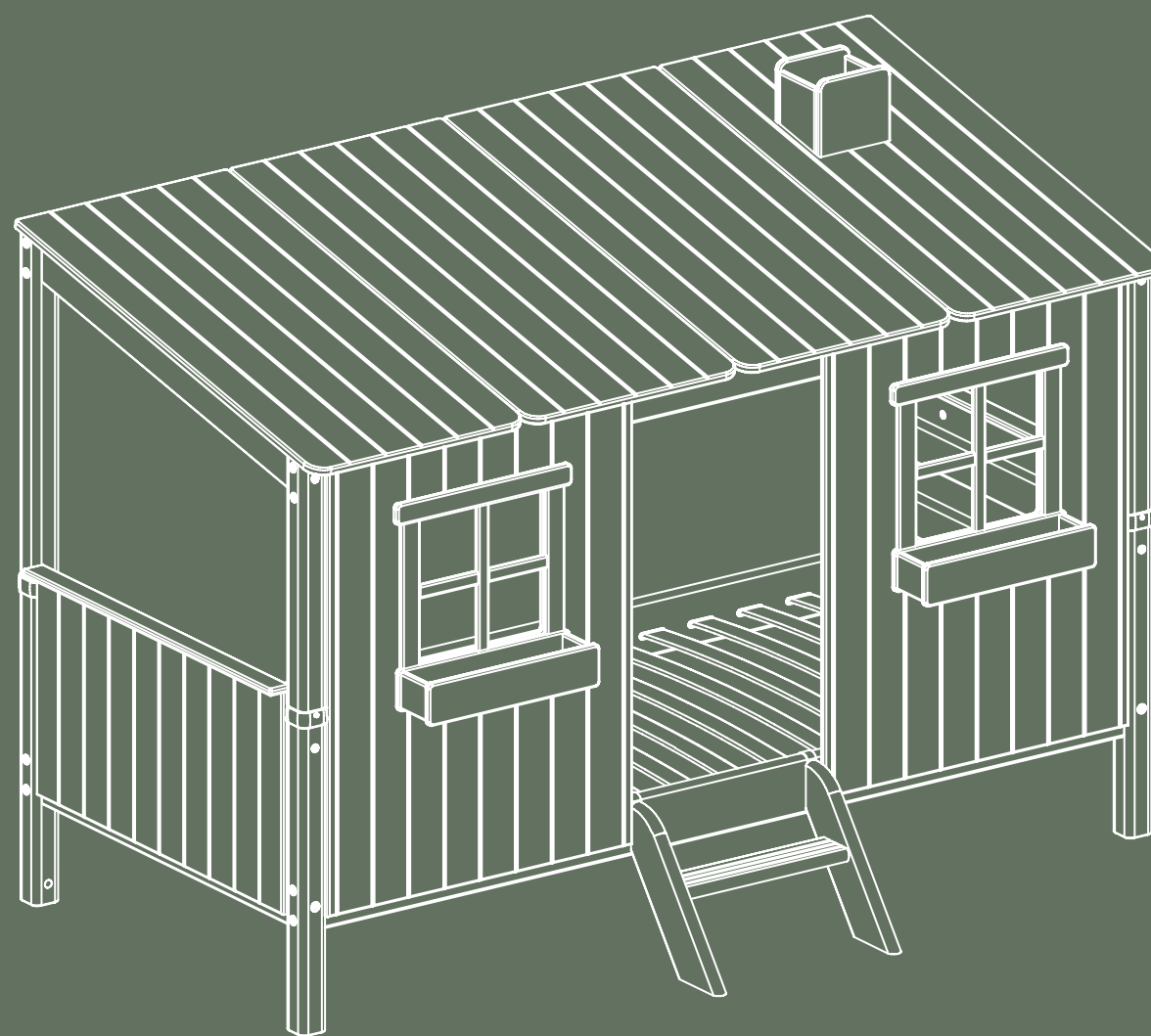

### Beds: Low

COLOUR OPTIONS 

	MATTRESS SIZE 90X200 CM	MATTRESS SIZE 90X190 CM		MATTRESS SIZE 90X200 CM	MATTRESS SIZE 90X190 CM
	80-01102-2 80-01102-3 L:210 W:100 H:67	80-01101-2 80-01101-3 L:200 W:100 H:67		90-10134-2-01 90-10134-3-01 L:210 W:100 H:67	90-10128-2-01 90-10128-3-01 L:200 W:100 H:67
	80-01220-2 80-01220-3 L:210 W:130 H:67	80-01219-2 80-01219-3 L:200 W:130 H:67		90-10170-2-01 90-10170-3-01 L:210 W:100 H:67	90-10169-2-01 90-10169-3-01 L:200 W:100 H:67
	80-01202-2 80-01202-3 L:210 W:150 H:67	80-01201-2 80-01201-3 L:200 W:150 H:67		90-10172-2-01 90-10172-3-01 L:210 W:100 H:67	90-10171-2-01 90-10171-3-01 L:200 W:100 H:67
	90-10122-2-01 90-10122-3-01 L:210 W:100 H:67	90-10121-2-01 90-10121-3-01 L:200 W:100 H:67		90-10157-2-01 90-10157-3-01 L:210 W:100 H:81	90-10156-2-01 90-10156-3-01 L:200 W:100 H:81
	90-10772-90-01 90-10772-72-01 L:210 W:112 H:154	90-10771-90-01 90-10771-72-01 L:200 W:112 H:154		90-10767-90-01 90-10767-72-01 L:210 W:130 H:154	

### Beds: Mid-high

COLOUR OPTIONS 

	MATTRESS SIZE 90X200 CM	MATTRESS SIZE 90X190 CM		MATTRESS SIZE 90X200 CM	MATTRESS SIZE 90X190 CM
	90-10110-2-01 90-10110-3-01 L:210 W:110 H:120	90-10109-2-01 90-10109-3-01 L:200 W:110 H:120		90-10308-2-01 90-10308-3-01 L:210 W:149 H:120	90-10307-2-01 90-10307-3-01 L:200 W:149 H:120
	90-10114-2-01 90-10114-3-01 L:210 W:249 H:120	90-10113-2-01 90-10113-3-01 L:200 W:249 H:120		90-10310-2-01 90-10310-3-01 L:200 W:249 H:120	90-10309-2-01 90-10309-3-01 L:200 W:249 H:120
	90-10187-2-01 90-10187-3-01 L:242 W:174 H:120	90-10186-2-01 90-10186-3-01 L:242 W:174 H:120		90-10108-2 90-10108-3 L:210 W:160 H:120	90-10108-2-01 90-10108-3-01 L:200 W:160 H:120
	90-10769-90-01 90-10769-72-01 L:210 W:149 H:206	90-10768-90-01 90-10768-72-01 L:200 W:149 H:206		90-10770-90-01 90-10770-72-01 L:210 W:149 H:206	

### Beds: Semi-high

COLOUR OPTIONS 

	MATTRESS SIZE 90X200 CM	MATTRESS SIZE 90X190 CM		MATTRESS SIZE 90X200 CM	MATTRESS SIZE 90X190 CM
	90-10046-2-01 90-10046-3-01 L:210 W:110 H:143	90-10045-2-01 90-10045-3-01 L:200 W:110 H:143		90-10312-2-01 90-10312-3-01 L:210 W:157 H:143	90-10311-2-01 90-10311-3-01 L:200 W:157 H:143
	90-10044-2-01 90-10044-3-01 L:210 W:210 H:143 L:250-375 W:110 H:143	90-10043-2-01 90-10043-3-01 L:200 W:200 H:143 L:230-355 W:110 H:143		90-10314-2-01 90-10314-3-01 L:210 W:210 H:143 L:250-375 W:157 H:143	90-10313-2-01 90-10313-3-01 L:200 W:200 H:143 L:230-355 W:157 H:143
					



**Beds: Bunk Beds**

COLOUR OPTIONS

	<b>MATTRESS SIZE 90X200 CM</b>	<b>MATTRESS SIZE 90X190 CM</b>		<b>MATTRESS SIZE 90X200 CM</b>	<b>MATTRESS SIZE 90X190 CM</b>
	<ul style="list-style-type: none"> <li> 90-10032-2-01</li> <li> 90-10032-3-01</li> </ul> L:210 W:110 H:154	<ul style="list-style-type: none"> <li> 90-10031-2-01</li> <li> 90-10031-3-01</li> </ul> L:200 W:110 H:154		<ul style="list-style-type: none"> <li> 90-10038-2-01</li> <li> 90-10038-3-01</li> </ul> L:210 W:110 H:184	<ul style="list-style-type: none"> <li> 90-10037-2-01</li> <li> 90-10037-3-01</li> </ul> L:200 W:110 H:184
	<ul style="list-style-type: none"> <li> 90-10178-2-01</li> <li> 90-10178-3-01</li> </ul> L:210 W:110 H:154	<ul style="list-style-type: none"> <li> 90-10177-2-01</li> <li> 90-10177-3-01</li> </ul> L:200 W:110 H:154		<ul style="list-style-type: none"> <li> 90-10320-2-01</li> <li> 90-10320-3-01</li> </ul> L:210 W:161 H:184	<ul style="list-style-type: none"> <li> 90-10319-2-01</li> <li> 90-10319-3-01</li> </ul> L:200 W:161 H:184

**Beds: High**

COLOUR OPTIONS

	<b>MATTRESS SIZE 90X200 CM</b>	<b>MATTRESS SIZE 90X190 CM</b>		<b>MATTRESS SIZE 90X200 CM</b>	<b>MATTRESS SIZE 90X190 CM</b>
	<ul style="list-style-type: none"> <li> 90-10070-2-01</li> <li> 90-10070-3-01</li> </ul> L:210 W:110 H:184	<ul style="list-style-type: none"> <li> 90-10069-2-01</li> <li> 90-10069-3-01</li> </ul> L:200 W:110 H:184		<ul style="list-style-type: none"> <li> 90-10316-2-01</li> <li> 90-10316-3-01</li> </ul> L:210 W:179 H:184	<ul style="list-style-type: none"> <li> 90-10315-2-01</li> <li> 90-10315-3-01</li> </ul> L:200 W:179 H:184
	<ul style="list-style-type: none"> <li> 90-10621-2-01</li> <li> 90-10621-3-01</li> </ul> L:210 W:160 H:184	<ul style="list-style-type: none"> <li> 90-10620-2-01</li> <li> 90-10620-3-01</li> </ul> L:200 W:160 H:184		<ul style="list-style-type: none"> <li> 90-10623-2-01</li> <li> 90-10623-3-01</li> </ul> L:210 W:229 H:184	<ul style="list-style-type: none"> <li> 90-10622-2-01</li> <li> 90-10622-3-01</li> </ul> L:200 W:229 H:184
	<ul style="list-style-type: none"> <li> 90-10917-2-01</li> <li> 90-10917-3-01</li> </ul> L:210 W:110 H:184	<ul style="list-style-type: none"> <li> 90-10916-2-01</li> <li> 90-10916-3-01</li> </ul> L:200 W:110 H:184			<ul style="list-style-type: none"> <li> 90-10919-2-01</li> <li> 90-10919-3-01</li> </ul> L:210 W:179 H:184
	<ul style="list-style-type: none"> <li> 90-11160-2-01</li> <li> 90-11160-3-01</li> </ul> L:210 W:110 H:184	<ul style="list-style-type: none"> <li> 90-11159-2-01</li> <li> 90-11159-3-01</li> </ul> L:200 W:110 H:184			<ul style="list-style-type: none"> <li> 90-11162-2-01</li> <li> 90-11162-3-01</li> </ul> L:210 W:179 H:184



### Bed Accessories

COLOUR OPTIONS



82-70106  
D:10 W:40 H:55



82-70100  
D:10 W:40 H:55



82-70094  
D:10 W:35 H:30



82-70088-40  
D:25 W:60 H:9



83-20243  
83-20244  
H:63 L:87



82-50031-2  
82-50031-3  
L:44 W:25 H:11



81-20705-2  
L:72 W:18 H:22



81-20745-2  
L:87 W:9 H:23



Foam casa mattress set 5 parts. - Light grey woven  
83-10393



83-90246  
83-90247  
H:15 L:197

### Storage: Low - Fits under mid-high beds

COLOUR OPTIONS COLOUR OPTIONS KNOBS



81-36301-500  
81-36301-501  
81-36301-502  
81-36301-503  
W:72 H:75 D:44



81-36301-90  
81-36301-508  
81-36301-509  
81-36301-510  
W:72 H:75 D:44



81-36301-504  
81-36301-505  
81-36301-506  
81-36301-507  
W:72 H:75 D:44



81-36301-72  
81-36301-511  
81-36301-512  
81-36301-513  
W:72 H:75 D:44



81-36401-500  
81-36401-501  
81-36401-502  
81-36401-503  
W:72 H:75 D:44



81-36401-90  
81-36401-508  
81-36401-509  
81-36401-510  
W:72 H:75 D:44



81-36401-504  
81-36401-505  
81-36401-506  
81-36401-507  
W:72 H:75 D:44



81-36401-72  
81-36401-511  
81-36401-512  
81-36401-513  
W:72 H:75 D:44



81-36201-2  
81-36201-3  
W:72 H:75 D:35



81-36203-2  
81-36203-3  
W:86 H:75 D:35



81-36202-2  
81-36202-3  
W:124 H:75 D:35

### Storage

COLOUR OPTIONS COLOUR OPTIONS KNOBS



81-36101-500  
81-36101-501  
81-36101-502  
81-36101-503  
W:36 H:52 D:44



81-36101-90  
81-36101-508  
81-36101-509  
81-36101-510  
W:36 H:52 D:44



81-36101-504  
81-36101-505  
81-36101-506  
81-36101-507  
W:36 H:52 D:44



81-36101-72  
81-36101-511  
81-36101-512  
81-36101-513  
W:36 H:52 D:44

### Storage: Wall hanging

COLOUR OPTIONS



90-10109-2-01  
90-10109-3-01  
L:200 W:110 H:120



90-10109-2-01  
90-10109-3-01  
L:200 W:110 H:120



90-10109-2-01  
90-10109-3-01  
L:200 W:110 H:120



81-36505-2  
81-36505-3  
W:72 H:138 D:35

### Storage: High - Fits under high beds

COLOUR OPTIONS

### Storage: Wardrobes

COLOUR OPTIONS COLOUR OPTIONS KNOBS



81-36507-500  
81-36507-501  
81-36507-502  
81-36507-503  
W:150 H:203 D:57



81-36507-90  
81-36507-508  
81-36507-509  
81-36507-510  
W:150 H:203 D:57



81-36507-504  
81-36507-505  
81-36507-506  
81-36507-507  
W:150 H:203 D:57



81-36507-72  
81-36507-511  
81-36507-512  
81-36507-513  
W:150 H:203 D:57



81-36501-500  
81-36501-501  
81-36501-502  
81-36501-503  
W:101 H:203 D:57



81-36501-90  
81-36501-508  
81-36501-509  
81-36501-510  
W:101 H:203 D:57



81-36501-504  
81-36501-505  
81-36501-506  
81-36501-507  
W:101 H:203 D:57



81-36501-72  
81-36501-511  
81-36501-512  
81-36501-513  
W:101 H:203 D:57





Storage: Study

COLOUR  
OPTIONS



COLOUR  
OPTIONS KNOBS



- 81-36504-500
  - 81-36504-501
  - 81-36504-502
  - 81-36504-503
- W:150 H:203 D:57



- 81-36504-90
  - 81-36504-508
  - 81-36504-509
  - 81-36504-510
- W:150 H:203 D:57



- 81-36504-504
  - 81-36504-505
  - 81-36504-506
  - 81-36504-507
- W:150 H:203 D:57



- 81-36504-72
  - 81-36504-511
  - 81-36504-512
  - 81-36504-513
- W:150 H:203 D:57



- 81-36701-2
  - 81-36701-3
- W:126 H:203 D:35

Storage: Study

COLOUR  
OPTIONS



- 82-50176-2
- D:70 W:120 H:50-83



- 82-50176-514
  - 82-50176-503
  - 82-50176-502
- D:70 W:120 H:50-83



- 82-50176-3
- D:70 W:120 H:50-83



- 82-50176-515
  - 82-50176-507
  - 82-50176-506
  - 82-50176-504
- D:70 W:120 H:50-83



- 90-10109-2-01
- D:70 W:120 H:50-83



- 82-50175-2
  - 82-50175-3
- D:65 W:120 H:70





# The Popsicle Collection

— *Pure & Peaceful*

Providing a flexible system designed to grow with the child.  
Beds, space-saving storage units, and desks in a playful design.  
For peaceful nights and joyful days.

## Why FLEXA Popsicle

- ◆ Flexible system designed to grow with the changing needs of every child
- ◆ Dusty colours combined with the finest oak wood and invisible fittings
- ◆ Space-saving storage solutions for each bed type
- ◆ Made from FSC™ certified wood
- ◆ Designed in Denmark

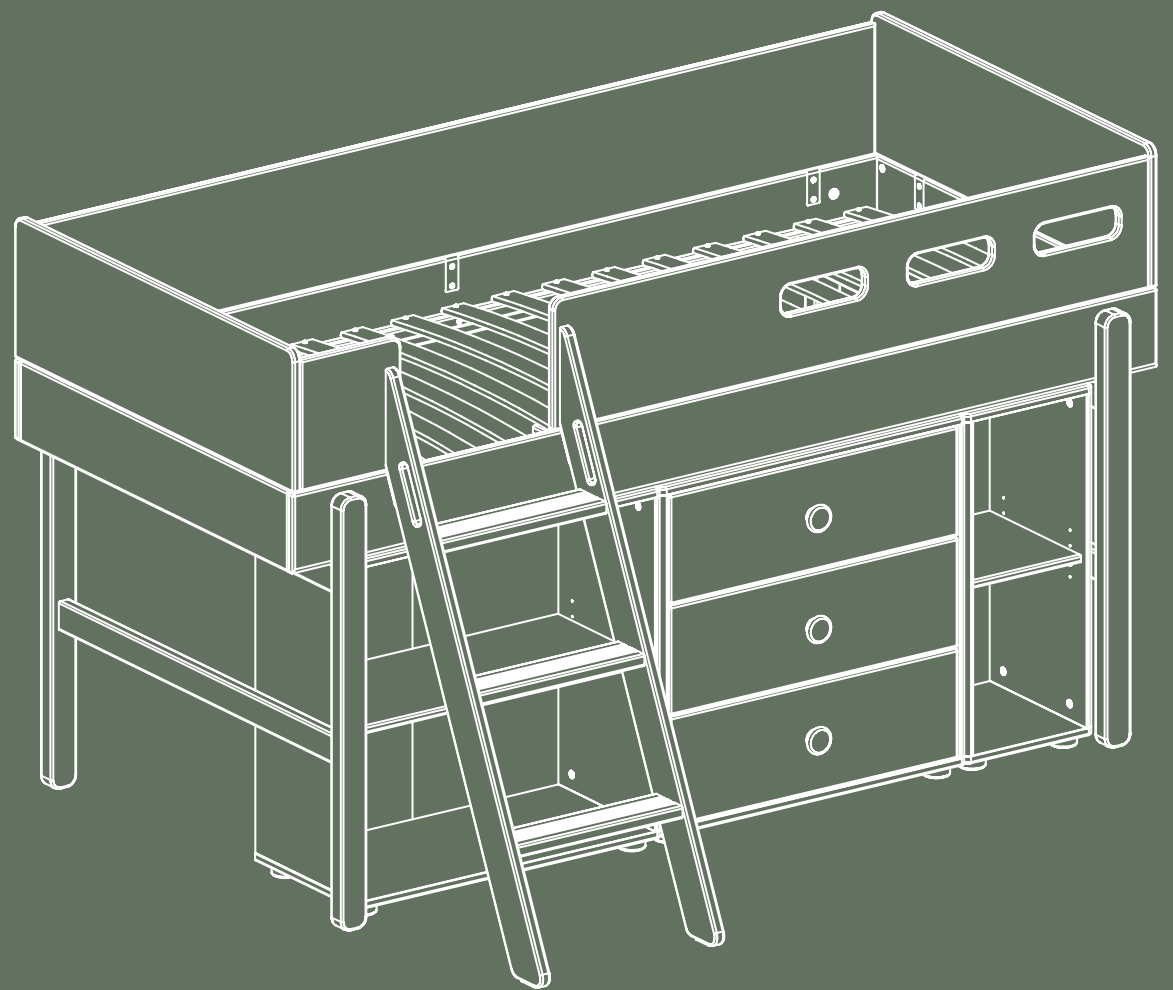

### Beds: Low

COLOUR OPTIONS  MATTRESS SIZE 90X200 CM



- 80-24101-31
- 80-24101-32
- 80-24101-33

L:204 W:102 H:38



- 80-24103-31
- 80-24103-32
- 80-24103-33

L:204 W:102 H:54



- 80-24102-31
- 80-24102-32
- 80-24102-33

L:204 W:102 H:67



- 80-24209-31
- 80-24209-32
- 80-24209-33

L:204 W:132 H:67



- 80-24201-31
- 80-24201-32
- 80-24201-33

L:204 W:132 H:90



- 80-24603-15
- 80-24603-17
- 80-24603-26

L: 94 H: 24

### Beds: Mid-high

COLOUR OPTIONS  MATTRESS SIZE 90X200 CM



- 80-24301-31
- 80-24301-32
- 80-24301-33

L:204 W:108 H:121



- 80-24302-31
- 80-24302-32
- 80-24302-33

L:204 W:151 H:121



- 90-10765-31
- 90-10765-32
- 90-10765-33

L:256 W:102 H:121



- 90-10920-31
- 90-10920-32
- 90-10920-33

L:204 W:108 H:121



- 90-10921-31
- 90-10921-32
- 90-10921-33

L:204 W:151 H:121



- 90-10922-31
- 90-10922-32
- 90-10922-33

L:256 W:102 H:121

### Beds: High

COLOUR OPTIONS  MATTRESS SIZE 90X200 CM



- 80-24502-31
- 80-24502-32
- 80-24502-33

L:204 W:182 H:185



- 90-10766-31
- 90-10766-32
- 90-10766-33

L:256 W:148 H:185

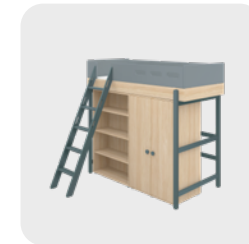

- 90-10923-31
- 90-10923-32
- 90-10923-33

L:204 W:182 H:185

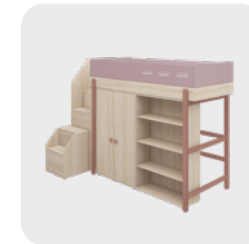

- 90-10924-31
- 90-10924-32
- 90-10924-33

L:256 W:148 H:185

### Beds: Bunk Beds

COLOUR OPTIONS  MATTRESS SIZE 90X200 CM

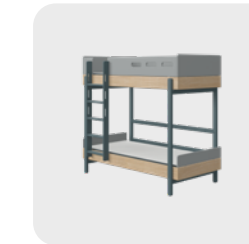

- 80-24401-31
- 80-24401-32
- 80-24401-33

L:204 W:108 H:185



- 80-24404-31
- 80-24404-32
- 80-24404-33

L:204 W:162 H:185



- 90-10764-31
- 90-10764-32
- 90-10764-33

L:256 W:152 H:185

### Storage: Low - Fits under mid-high beds

COLOUR OPTIONS  KNOBS



81-30201-30  
D:35 W:30 H:74



81-30202-30  
D:35 W:72 H:74

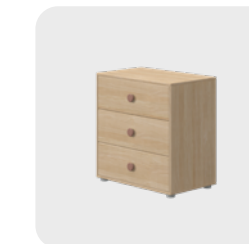

- 81-30301-31
- 81-30301-32
- 81-30301-33

D:44 W:72 H:74

Storage: High - Fits under high beds

COLOUR OPTIONS  
KNOBS



D:35 W:38 H:138  
81-30501-30



D:35 W:88 H: 138  
81-30502-30



81-30503-31  
81-30503-32  
81-30503-33  
D:57 W:88 H:138

Storage: Wardrobes

COLOUR OPTIONS  
KNOBS



81-30504-31  
81-30504-32  
81-30504-33  
D:57 W:101 H:202



81-30505-31  
81-30505-32  
81-30505-33  
D:57 W:51 H:202

Desks

COLOUR  
OPTIONS



82-50127-31  
82-50127-32  
82-50127-33  
D:60 W:124 H:74



82-20140-31  
82-20140-32  
82-20140-33  
D:35 W:28 H:8



82-50176-31  
82-50176-32  
82-50176-33  
D:70 W:120 H:50-83



# The Dots Collection

— *Playful & Practical*

Full-room collection designed to fit children and their parents' needs. Beds, accessories, storage, and play furniture with joyful details. Because every day is a play day.

## Why FLEXA Dots

- ◆ A full-room collection designed to fit into any room at home
- ◆ Rounded edges for comfort and safety
- ◆ Ash wood with an urban colour palette
- ◆ Made from FSC™ certified wood
- ◆ Designed in Denmark







## Beds

COLOUR  
OPTIONS



MATTRESS SIZE  
90X200 CM



- 80-19101-110
  - 80-19101-120
  - 80-19101-130
  - 80-19101-132
  - 80-19101-40
- L: 204 H: 72 W: 96

MATTRESS SIZE  
90X190 CM



- 80-19102-110
  - 80-19102-120
  - 80-19102-130
  - 80-19102-132
  - 80-19102-40
- L: 194 H: 72 W: 96

MATTRESS SIZE  
90X200 CM

- 80-19902-110
  - 80-19902-120
  - 80-19902-130
  - 80-19902-132
  - 80-19902-40
- L: 204 H: 72 W: 96

MATTRESS SIZE  
90X190 CM

- 80-19901-110
  - 80-19901-120
  - 80-19901-130
  - 80-19901-132
  - 80-19901-40
- L: 194 H: 72 W: 96

SAFETY RAIL



- 80-19601-110
  - 80-19601-120
  - 80-19601-130
  - 80-19601-132
  - 80-19601-40
- L: 100 H: 24,5

COTBED



- 80-19802-40
- L: 124 H: 92 W: 64

## Storage

COLOUR  
OPTIONS



- 82-70087-110
  - 82-70087-120
  - 82-70087-130
  - 82-70087-132
  - 82-70087-40
- W: 60 H: 75 D: 22



- 82-70145-110
  - 82-70145-120
  - 82-70145-130
  - 82-70145-132
  - 82-70145-40
- W: 75 H: 34,5 D: 10



- 82-10060-110
  - 82-10060-120
  - 82-10060-130
  - 82-10060-132
  - 82-10060-40
- W: 65 H: 57,5 D: 35



- 82-10048-110
  - 82-10048-120
  - 82-10048-130
  - 82-10048-132
  - 82-10048-40
- W: 60 H: 42 D: 35

## Play Furniture

COLOUR  
OPTIONS



- 82-50103-110
  - 82-50103-120
  - 82-50103-130
  - 82-50103-132
  - 82-50103-40
- Ø: 60 H: 47



- 82-10047-110
  - 82-10047-120
  - 82-10047-130
  - 82-10047-132
  - 82-10047-40
- Ø: 30 H: 30



- 82-10059-110
  - 82-10059-120
  - 82-10059-130
  - 82-10059-132
  - 82-10059-40
- W: 33,4 H: 32,9 D: 54,1



# The White Collection

## — Subtle Simplicity

Providing a flexible system designed to grow with the child.  
Beds, desks, and bed accessories in a strong and simple design.  
Honest furniture for future generations.

### Why FLEXA White

- ◆ Flexible system designed to grow with the changing needs of every child
- ◆ Smooth surfaces in a strong and simple design
- ◆ Fits easily into the décor of any room
- ◆ Made from FSC™ certified wood
- ◆ Designed in Denmark

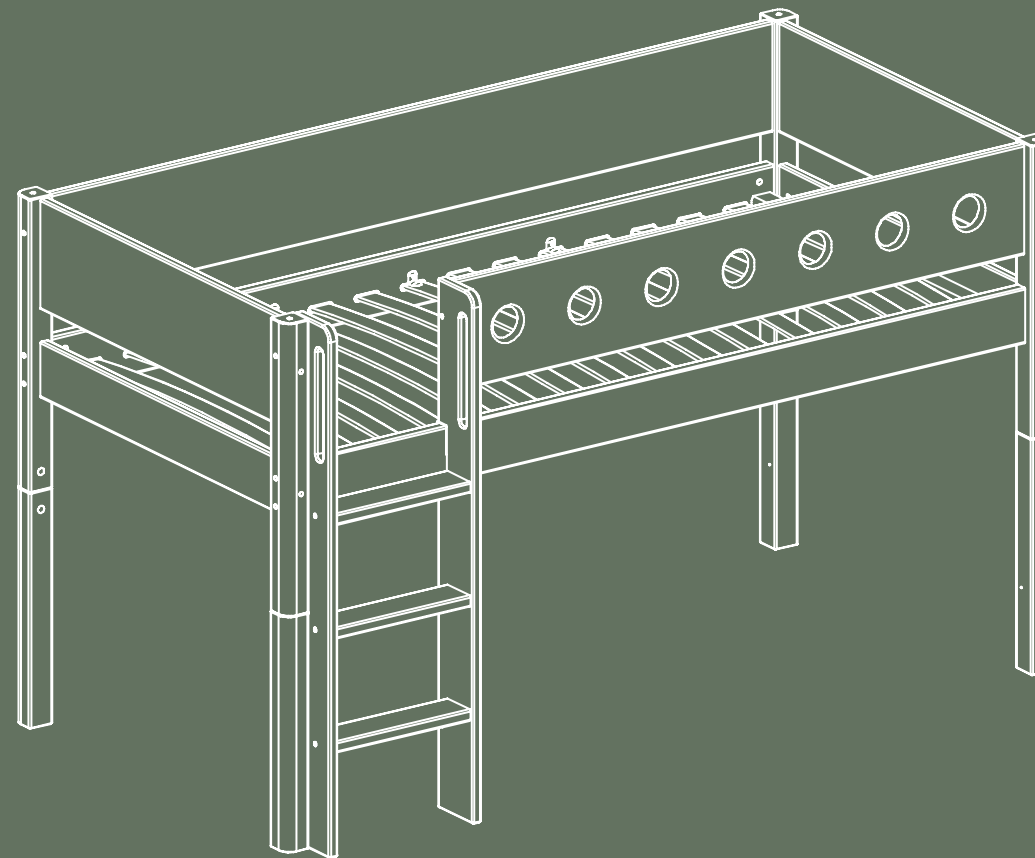





### Beds: low

COLOUR OPTIONS  
SAFETY RAIL











	MATTRESS SIZE 90X200 CM	MATTRESS SIZE 90X190 CM	MATTRESS SIZE 90X200 CM	MATTRESS SIZE 90X190 CM
	80-17102-40 L:210 W:101 H:67	80-17101-40 L:200 W:101 H:67		<input type="checkbox"/> 80-17120-518 <input type="checkbox"/> 80-17120-519 <input type="checkbox"/> 80-17120-40 L:210 W:101 H:67
	80-17118-40 L:210 W:101 H:67	80-17101-40 L:200 W:101 H:67		90-10756-40 L:210 W:101 H:67
	90-10760-40 L:210 W:101 H:81	90-10759-40 L:200 W:101 H:67		90-10758-40 L:210 W:101 H:67
				90-10755-40 L:200 W:101 H:67
				90-10757-40 L:200 W:101 H:67

### Beds: Mid-high

COLOUR OPTIONS  
SAFETY RAIL



	MATTRESS SIZE 90X200 CM	MATTRESS SIZE 90X190 CM	MATTRESS SIZE 90X200 CM	MATTRESS SIZE 90X190 CM
	<input type="checkbox"/> 80-17309-518 <input type="checkbox"/> 80-17309-519 <input type="checkbox"/> 80-17309-40 L:210 W:109 H:120	<input type="checkbox"/> 80-17308-518 <input type="checkbox"/> 80-17308-519 <input type="checkbox"/> 80-17308-40 L:200 W:109 H:120		90-10974-40 L:210 W:109 H:120
	<input type="checkbox"/> 80-17311-518 <input type="checkbox"/> 80-17311-519 <input type="checkbox"/> 80-17311-40 L:210 W:151 H:120	<input type="checkbox"/> 80-17310-518 <input type="checkbox"/> 80-17310-519 <input type="checkbox"/> 80-17310-40 L:200 W:151 H:120		90-10975-40 L:210 W:151 H:120
	<input type="checkbox"/> 80-17313-518 <input type="checkbox"/> 80-17313-519 <input type="checkbox"/> 80-17313-40 L:210 W:250 H:120	<input type="checkbox"/> 80-17312-518 <input type="checkbox"/> 80-17312-519 <input type="checkbox"/> 80-17312-40 L:200 W:250 H:120		90-10980-95 L:210 W:109 H:120
	<input type="checkbox"/> 80-17315-518 <input type="checkbox"/> 80-17315-519 <input type="checkbox"/> 80-17315-40 L:210 W:250 H:120	<input type="checkbox"/> 80-17314-518 <input type="checkbox"/> 80-17314-519 <input type="checkbox"/> 80-17314-40 L:200 W:250 H:120		90-10981-95 L:210 W:151 H:120
				90-10976-40 L:200 W:101 H:67
				90-10977-40 L:200 W:101 H:67
				90-10982-95 L:200 W:101 H:67
				90-10983-95 L:200 W:101 H:67

Composition unavailable in France

Composition unavailable in France

### Beds: Semi-high

COLOUR OPTIONS SAFETY RAIL 

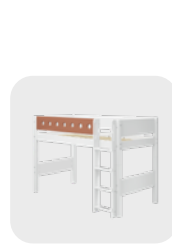

**MATTRESS SIZE 90X200 CM**  
 ■ 80-17326-518  
 ■ 80-17326-519  
 □ 80-17326-40  
 L:210 W:109 H:143

**MATTRESS SIZE 90X190 CM**  
 ■ 80-17325-518  
 ■ 80-17325-519  
 □ 80-17325-40  
 L:200 W:109 H:143



**MATTRESS SIZE 90X200 CM**  
 ■ 80-17328-518  
 ■ 80-17328-519  
 □ 80-17328-40  
 L:210 W:159 H:143

**MATTRESS SIZE 90X190 CM**  
 ■ 80-17327-518  
 ■ 80-17327-519  
 □ 80-17327-40  
 L:200 W:159 H:143

### Beds: Bunk Beds

COLOUR OPTIONS SAFETY RAIL 



**MATTRESS SIZE 90X200 CM**  
 ■ 80-17407-518  
 ■ 80-17407-519  
 □ 80-17407-40  
 L:210 W:109 H:154

**MATTRESS SIZE 90X190 CM**  
 ■ 80-17406-518  
 ■ 80-17406-519  
 □ 80-17406-40  
 L:200 W:109 H:154



**MATTRESS SIZE 90X200 CM**  
 ■ 80-17414-518  
 ■ 80-17414-519  
 □ 80-17414-40  
 L:210 W:109 H:184

**MATTRESS SIZE 90X190 CM**  
 ■ 80-17413-518  
 ■ 80-17413-519  
 □ 80-17413-40  
 L:200 W:109 H:184

### Beds: High

COLOUR OPTIONS SAFETY RAIL 



**MATTRESS SIZE 90X200 CM**  
 ■ 80-17502-518  
 ■ 80-17502-519  
 □ 80-17502-40  
 L:210 W:109 H:184

**MATTRESS SIZE 90X190 CM**  
 ■ 80-17501-518  
 ■ 80-17501-519  
 □ 80-17501-40  
 L:200 W:109 H:184



**MATTRESS SIZE 90X200 CM**  
 ■ 80-17525-518  
 ■ 80-17525-519  
 □ 80-17525-40  
 L:210 W:109 H:184

**MATTRESS SIZE 90X190 CM**  
 ■ 80-17524-518  
 ■ 80-17524-519  
 □ 80-17524-40  
 L:200 W:109 H:184



■ 90-11156-518  
 ■ 90-11156-519  
 □ 90-11156-40  
 L:210 W:109-181 H:184

■ 90-11155-518  
 ■ 90-11155-519  
 □ 90-11155-40  
 L:200 W:109-179 H:184

### Bed Accessories



82-70217-40  
L:89/99 H:74



82-70218-95  
L:89/99 H:74



82-70103  
H:55 W:40 D:10



82-70097  
H:55 W:40 D:10



82-70091  
H:30 W:35 D:10



82-70089-40  
H:9 W:60 D:25



82-70109  
H:4 W:25 D:20



Foam casa mattress set 5 parts. - Light grey woven  
83-10393

### Deks



82-50176-40  
H:50-83 W:120 D:70



82-50149  
H:59-83 W:120 D:70



82-50150  
H:59-83 W:120 D:70



82-50148  
H:59-83 W:120 D:70



82-50081-40  
H:65-75 W:122 D:61



82-50146  
H:56-79 W:120 D:70



82-50147  
H:56-79 W:120 D:70





# The Nor Collection

— *Calm & Timeless*

Providing a flexible system designed to grow with the child.  
Beds, desk and bed accessories in a timeless design.  
For a calm and Nordic feel.

## Why FLEXA Nor

- ◆ Flexible system designed to grow with the changing needs of every child
- ◆ Pure and smooth surfaces with solid oak legs
- ◆ Calm and timeless design
- ◆ Made from FSC™ certified wood
- ◆ Designed in Denmark

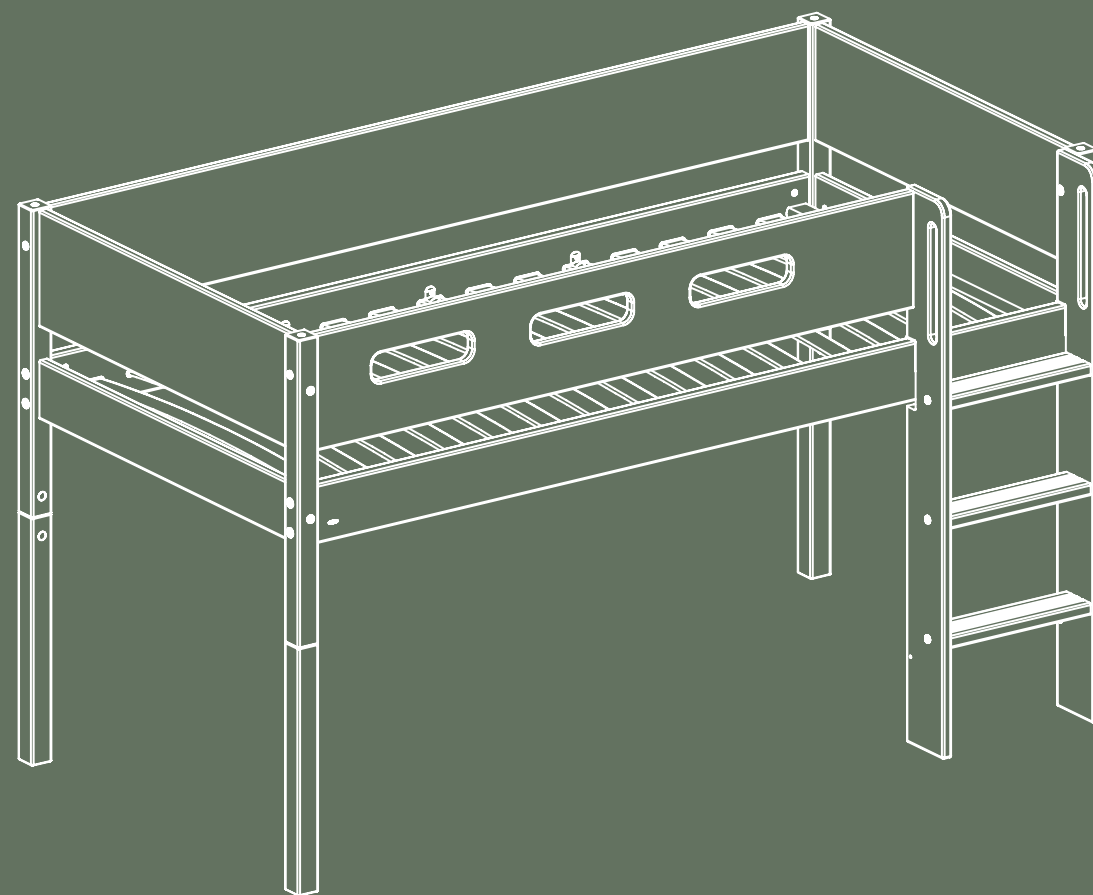

Beds: Low

	MATTRESS SIZE 90X200 CM	MATTRESS SIZE 90X190 CM		MATTRESS SIZE 90X200 CM	MATTRESS SIZE 90X190 CM
	80-31102-95 L:208 W:99 H:67	80-31101-95 L:198 W:99 H:67		80-31106-95 L:208 W:99 H:67	80-31105-95 L:198 W:99 H:67
	80-31108-95 L:208 W:99 H:67	80-31107-95 L:198 W:99 H:67		90-10813-95 L:208 W:99 H:67	90-10812-95 L:198 W:99 H:67
	90-10815-95 L:208 W:99 H:67	90-10814-95 L:198 W:99 H:67		90-10817-95 L:208 W:99 H:81	90-10816-95 L:198 W:99 H:81

Beds: Mid-high

	MATTRESS SIZE 90X200 CM	MATTRESS SIZE 90X190 CM		MATTRESS SIZE 90X200 CM	MATTRESS SIZE 90X190 CM
	80-31102-95 L:208 W:99 H:67	80-31301-95 L:198 W:108 H:120		80-31106-95 L:208 W:99 H:67	80-31303-95 L:198 W:150 H:120
	80-31108-95 L:208 W:99 H:67	80-31305-95 L:198 W:249 H:120		90-10813-95 L:208 W:99 H:67	80-31307-95 L:198 W:249 H:120
	90-10986-95 L:208 W: 109 H: 120	90-10988-95 L:200 W: 109 H: 120		90-10987-95 L:208 W: 109 H: 120	90-10989-95 L:200 W: 109 H: 120
	90-10992-95 L:208 W: 109 H: 120	90-10994-95 L:200 W: 109 H: 120		90-10993-95 L:208 W: 109 H: 120	90-10995-95 L:200 W: 109 H: 120

Beds: Semi-High

	MATTRESS SIZE 90X200 CM	MATTRESS SIZE 90X190 CM		MATTRESS SIZE 90X200 CM	MATTRESS SIZE 90X190 CM
	80-31316-95 L:208 W:108 H:143	80-31315-95 L:198 W:99 H:67		80-31318-95 L:208 W:158 H:143	80-31317-95 L:198 W:99 H:67







## Beds: Bunk Beds



**MATTRESS SIZE  
90X200 CM**  
80-31402-95  
L:208 W:108 H:154

**MATTRESS SIZE  
90X190 CM**  
80-31401-95  
L:198 W:108 H:154



**MATTRESS SIZE  
90X200 CM**  
80-31406-95  
L:208 W:108 H:184

**MATTRESS SIZE  
90X190 CM**  
80-31405-95  
L:198 W:108 H:184

## Beds: High



**MATTRESS SIZE  
90X200 CM**  
80-31502-95  
L:208 W:108 H:184

**MATTRESS SIZE  
90X190 CM**  
80-31501-95  
L:198 W:108 H:184



**MATTRESS SIZE  
90X200 CM**  
80-31512-95  
L:208 W:108 H:184

**MATTRESS SIZE  
90X190 CM**  
80-31511-95  
L:198 W:108 H:184



90-11158-95  
L:208 W:109-181 H:184

90-11157-95  
L:198 W:109-179 H:184

Composition unavailable in UK

## Bed Accessories



Fits under mid-high beds

82-70217-40  
L:89/99 H:74



Fits under mid-high beds

82-70218-95  
L:89/99 H:74



82-70103  
H:55 W:40 D:10

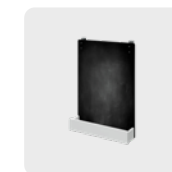

82-70097  
H:55 W:40 D:10



82-70091  
H:30 W:35 D:10



82-70089-40  
H:9 W:60 D:25



82-70109  
H:4 W:25 D:20



83-10393  
Foam casa mattress set 5 parts. - Light grey woven

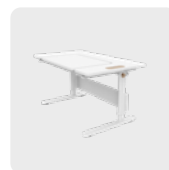

## Desks

82-50148  
H:59-83 W:120 D:7082-50149  
H:59-83 W:120 D:7082-50150  
H:59-83 W:120 D:7082-50146  
H:56-79 W:120 D:7082-50147  
H:56-79 W:120 D:7082-50176-40  
H:50-83 W:120 D:70

## Storage: Low - Fits under mid-high beds

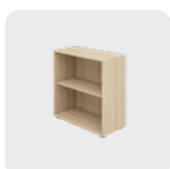
81-30201-30  
H:74 W:30 D:3581-30202-30  
H:74 W:72 D:3581-30301-40  
H:74 W:72 D:44

## Storage: Low - Fits under high beds

81-30501-30  
H:138 W:38 D:3581-30502-30  
H:138 W:88 D:3581-30503-40  
H:138 W:88 D:57

## Storage: Wardrobes

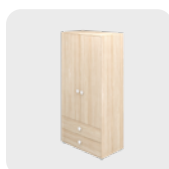
81-30504-40  
H:202 W:101 D:5781-30505-40  
H:202 W:51 D:57

# The Roomie Collection

— *Storage Made Fun*

Optimal space-saving solutions in a clean, Nordic design  
Full-coloured storage units with smooth edges and soft-close.  
More room for fun.

## Why FLEXA Roomie

- ◆ Optimal space-saving storage in a clean, Nordic design
- ◆ Full-coloured, smooth edges, and soft-close
- ◆ Easy to match with other FLEXA collections
- ◆ Made from FSC™ certified wood
- ◆ Designed in Denmark

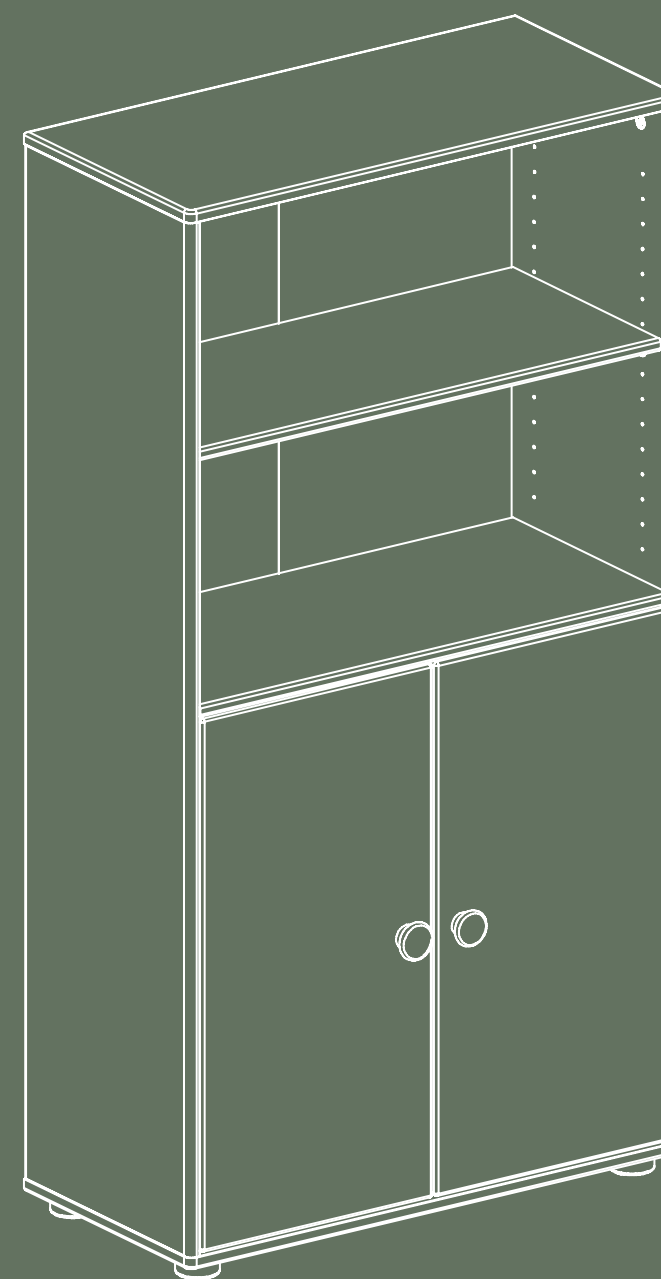





## Storage: Chests, Cupboards, and Shelf Unit

COLOUR OPTIONS  
KNOBS

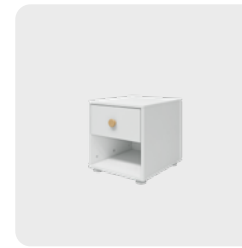

81-39101-40  
 81-39101-518  
 81-39101-519  
 81-39101-523  
 81-39101-524  
 81-39101-95  
 W:39 H:41 D:44



81-39301-40  
 81-39301-518  
 81-39301-519  
 81-39301-523  
 81-39301-524  
 81-39301-95  
 W:72 H:75 D:44



81-39401-40  
 81-39401-518  
 81-39401-519  
 81-39401-523  
 81-39401-524  
 81-39401-95  
 W:72 H:75 D:44



81-39201-40  
W:72 H:75 D:44

## Storage: Bookcases

COLOUR OPTIONS  
KNOBS



81-39403-40  
 81-39403-518  
 81-39403-519  
 81-39403-523  
 81-39403-524  
 81-39403-95  
 W:72 H:75 D:35

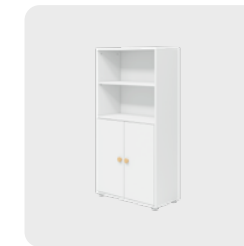

81-39514-40  
 81-39514-518  
 81-39514-519  
 81-39514-523  
 81-39514-524  
 81-39514-95  
 W:72 H:138 D:35



81-39510-40  
 81-39510-518  
 81-39510-519  
 81-39510-523  
 81-39510-524  
 81-39510-95  
 W:72 H:203 D:35



81-39201-40  
W:72 H:75 D:35

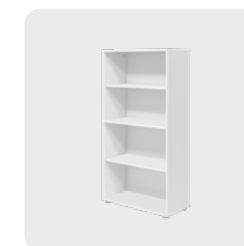

81-39511-40  
W:72 H:138 D:35

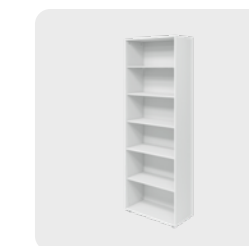

81-39507-40  
W:72 H:203 D:35



Storage: Wall-hanging

COLOUR OPTIONS 



- 81-30504-40
  - 81-26206-120
  - 81-26206-132
  - 81-26206-110
  - 81-26206-130
- W:72 H:35 D:35

Storage: Hutch



81-39702-40  
W:125 H:138 D:35

Storage: Wardrobes

COLOUR OPTIONS  
KNOBS 



- 81-39501-40
  - 81-39501-518
  - 81-39501-519
  - 81-39501-523
  - 81-39501-524
  - 81-39501-95
- W:101 H:203 D:57



- 81-39504-40
  - 81-39504-518
  - 81-39504-519
  - 81-39504-523
  - 81-39504-524
  - 81-39504-95
- W:150 H:203 D:57

Storage: Changing Units

COLOUR OPTIONS  
KNOBS 



- 90-11164-40
  - 90-11164-518
  - 90-11164-519
  - 90-11164-523
  - 90-11164-524
  - 90-11164-95
- W:72 H:97 D:44



- 90-11165-40
  - 90-11165-518
  - 90-11165-519
  - 90-11165-523
  - 90-11165-524
  - 90-11165-95
- W:72 H:97 D:44



90-11163-40  
W:72 H:97 D:44



# The Freja Collection

## — *Bed & Storage in One*

Combining space-saving solutions with Nordic design traditions. One piece of furniture with room for it all: sleeping, playing, and organising. For comfy nights and lively days.

### Why FLEXA Freja

- ◆ Functional design with space-saving solutions
- ◆ Nordic design with pure and smooth surfaces
- ◆ Bed size ensures functionality for many years
- ◆ Made from FSC™ certified wood
- ◆ Designed in Denmark

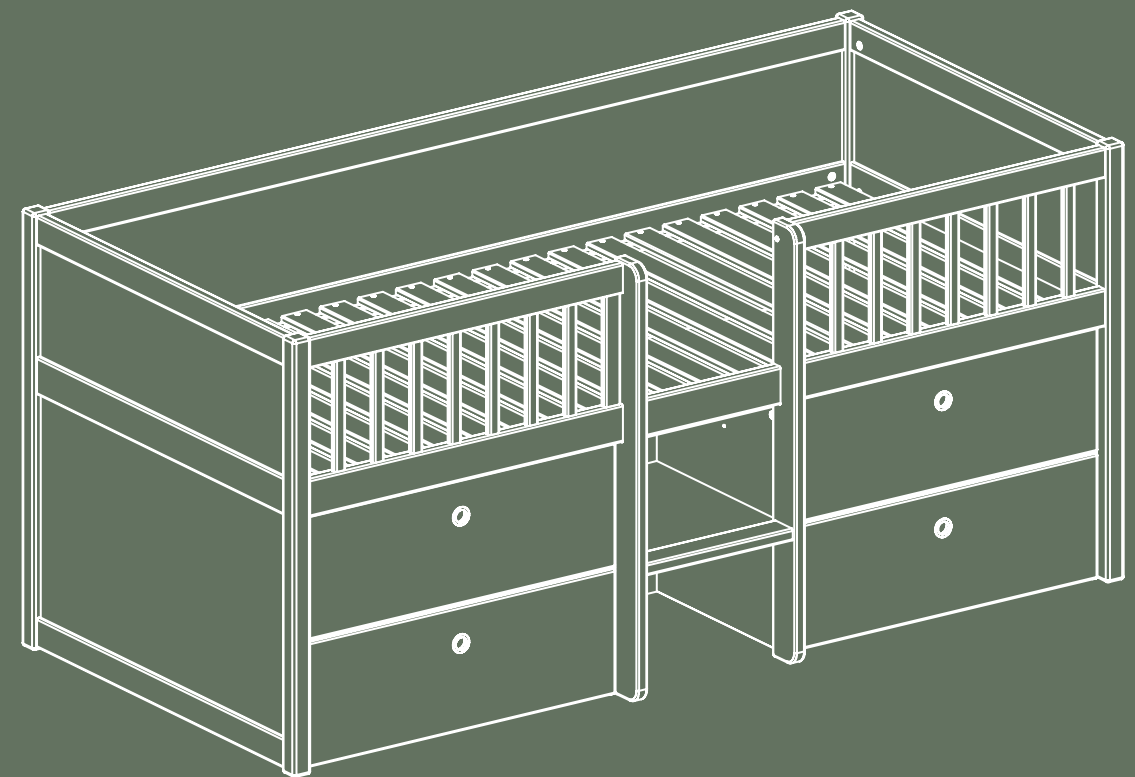



Beds



80-32901-40  
L:207 W:102 H:95

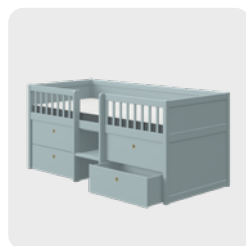

80-32901-53  
L:207 W:102 H:95



# Cottage Collection

— *Home for Dreams*

Adding a personal and playful touch to any room.  
House beds in a clean and minimalistic design.  
Where dreams come to life.

## Why FLEXA Cottage

- ◆ Minimalistic bed in a playful design
- ◆ Slatted bed frame for optimal airflow
- ◆ Fun to decorate and personalise
- ◆ Made from FSC™ certified wood
- ◆ Designed in Denmark

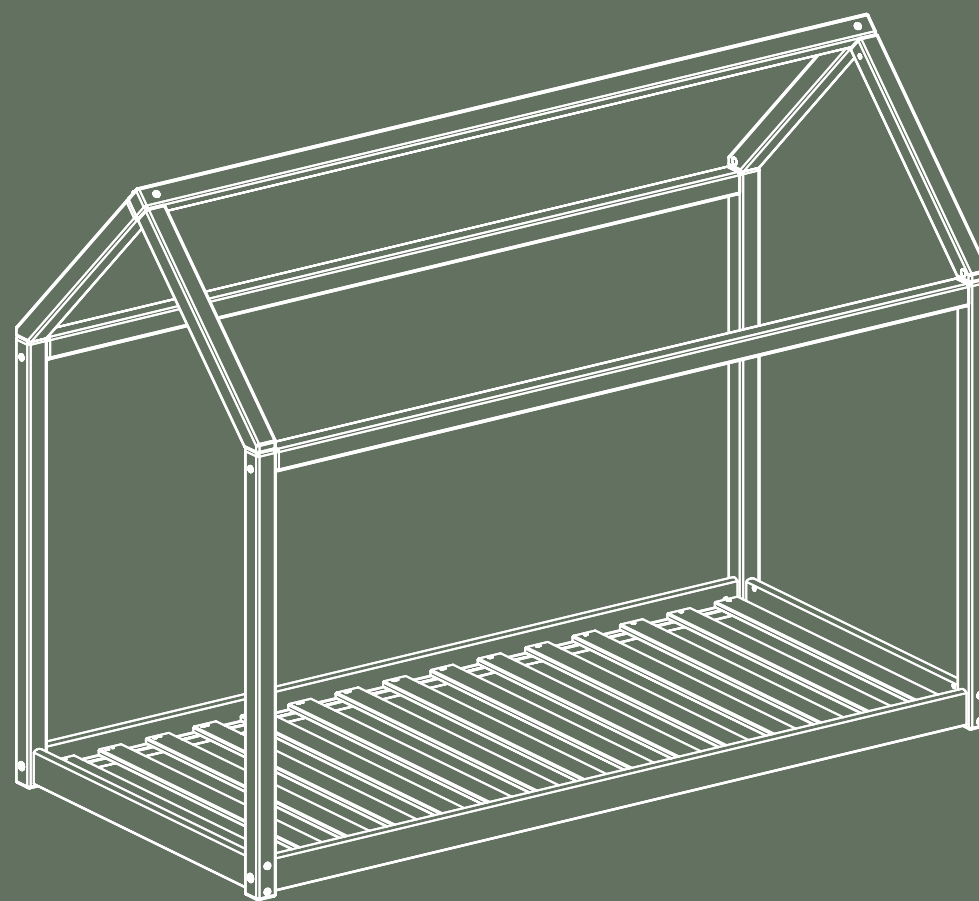





Beds: Mid-high

COLOUR  
OPTIONS



MATTRESS SIZE  
90X200 CM



80-06901  
L:207 W:102 H:95



80-06901  
+ 83-60012  
L:207 W:102 H:95



80-06901  
+ 83-60013  
L:207 W:102 H:95



80-06901  
L:207 W:102 H:95



80-06901  
+ 83-60012  
L:207 W:102 H:95



80-06901  
+ 83-60013  
L:207 W:102 H:95



# The Textile Collection

## — Colourful Textiles

Decorating with textiles gives children the possibility to put their own personal touch on their room. A play curtain or a cave with a fun and playful print can inspire hours of imaginative play and bed linen in their favourite colour can help turn their bed into their happy place.

All our textiles are OEKO-TEX® certified and comply with EU's strictest product safety standards, so parents can be sure that providing children with FLEXA textiles is stimulating and safe.





## Safari

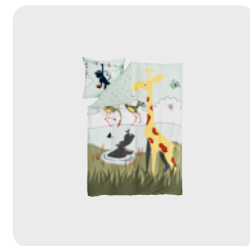

**83-70432**  
L:60 B:63 / L:200 B:140  
**83-70433**  
L:50 B:70 / L:200 B:140  
**83-70434**  
L:80 B:80 / L:200 B:140

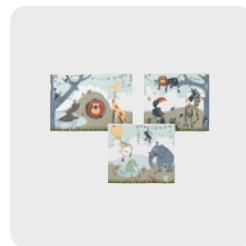

**83-20241**  
L: 110 H: 77  
L: 87 H: 77  
L: 87 H: 77



**83-20242**  
L: 197 H: 25  
L: 90 H: 25

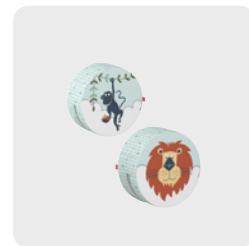

**83-70431**  
Ø: 30



**83-40056**  
L:105 W: 90 H: 85



**83-90229**  
L:29 H: 40

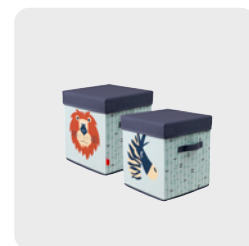

**82-70117**  
L:29,5 W: 29,5 H:30,5

## Little Princess



**83-70532**  
L:60 B:63 / L:200 B:140  
**83-70533**  
L:50 B:70 / L:200 B:140  
**83-70534**  
L:80 B:80 / L:200 B:140



**83-20247**  
L: 110 H: 77  
L: 87 H: 77  
L: 87 H: 77

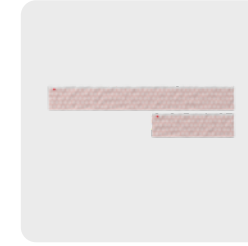

**83-20248**  
L: 197 H: 25  
L: 90 H: 25

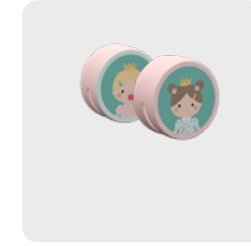

**83-70531**  
Ø: 30



**83-40059**  
L:105 W: 90 H: 85



**83-90255**  
L:29 H: 40



**82-70187**  
L:29,5 W: 29,5 H:30,5

## Transportation



**83-70375**  
L:60 B:63 / L:200 B:140  
**83-70376**  
L:50 B:70 / L:200 B:140  
**83-70377**  
L:80 B:80 / L:200 B:140

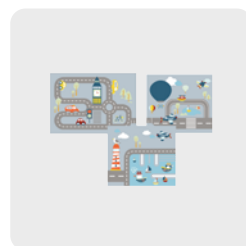

**83-20235**  
L: 110 H: 77  
L: 87 H: 77  
L: 87 H: 77

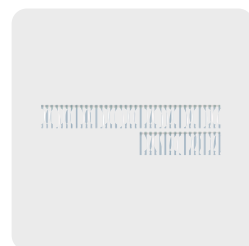

**83-20236**  
L: 197 H: 25  
L: 90 H: 25



**83-70374**  
Ø: 30



**83-40051**  
L:105 W: 90 H: 85

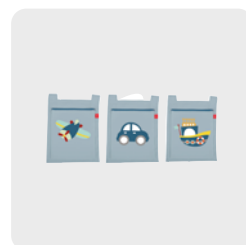

**83-90219**  
L:29 H: 40



**82-70178**  
L:29,5 W: 29,5 H:30,5

## Little Heroes

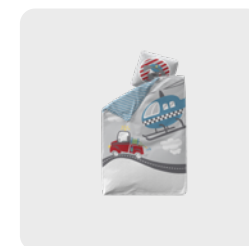

**83-70536**  
L:60 B:63 / L:200 B:140  
**83-70537**  
L:50 B:70 / L:200 B:140  
**83-70538**  
L:80 B:80 / L:200 B:140

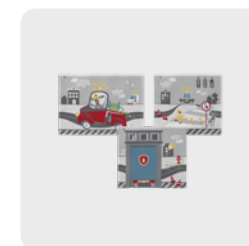

**83-20249**  
L: 110 H: 77  
L: 87 H: 77  
L: 87 H: 77

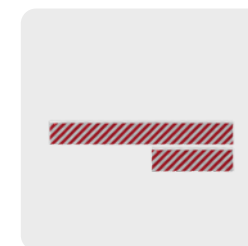

**83-20250**  
L: 197 H: 25  
L: 90 H: 25

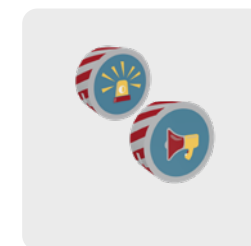

**83-70535**  
Ø: 30

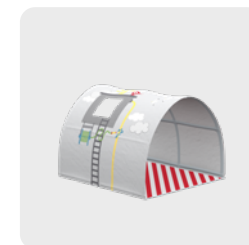

**83-40060**  
L:105 W: 90 H: 85



**83-90258**  
L:29 H: 40



**82-70188**  
L:29,5 W: 29,5 H:30,5

# FLEXA Play

## — More than Just Toys

At FLEXA, we want to improve children's lives. Our focus is to ensure a healthy and natural development through play for children across the globe. And so, our toys are created with the most recent knowledge of children's development in mind.

They are made from FSC™ certified wood and have rounded edges for comfort and safety. The FLEXA Play family of toys encourage children to MOVE, CREATE, IMAGINE, and EXPLORE.

### Why FLEXA Play

- ◆ Especially selected and designed to support children's development
- ◆ Calming colour scheme to avoid overstimulation
- ◆ Rounded edges for comfort and safety
- ◆ Made from FSC™ certified wood
- ◆ Designed in Denmark







Every FLEXA Play product is designed to encourage children to **MOVE**, **CREATE**, **IMAGINE** or **EXPLORE**.

## MOVE

Encouraging children's movement through play

Crawling, walking, running, jumping, gross motor skills

Improving your child's physical condition and balance

## CREATE

Helping children develop a creative mindset

Creativity, thinking outside the box, expressing oneself

Inspiring your child to experiment with new ideas

## IMAGINE

Giving children the freedom to use their imagination

Dreaming, being curious and empathetic

Evolving your child's social skills, language skills and integrity

## EXPLORE

Stimulating children's cognitive development

Focusing, concentrating, reasoning, fine motor skills

Developing your child's ability to concentrate and think logically



COLLECTION OVERVIEW

# MOVE

Encouraging children's movement through play

Crawling, walking, running, jumping, gross motor skills

Improving your child's physical condition and balance



Balance Board - mini  
88-10710-131



Balance Board - mini  
88-10710-120



The Wooden Slide  
88-10733-131



The Surfer  
88-10715-110



Slide for Play Tower  
88-10705-120



Play Tower - midi  
88-10720-120



Play Tower with Slide - midi  
88-10725-120



The Balance Bike  
88-10700-110



## COLLECTION OVERVIEW

**CREATE**

Helping children develop a creative mindset

Creativity, thinking outside the box, expressing oneself

Inspiring your child to experiment with its ideas



**Rattle Set- mini**  
88-13221-150

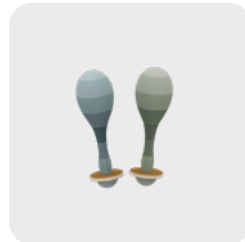

**Maracas Set**  
88-13232-150

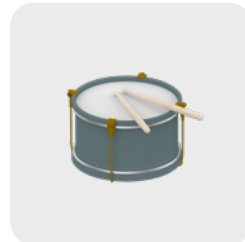

**Wooden Drum - midi**  
88-13133-141



**Xylophone - mini**  
88-13336-150



**Flute and Clapper**  
88-13215-150



**The Creative Table**  
88-13750-100



**Creative Table Stool**  
88-13760-100



**Paper Roll**  
88-13650-115

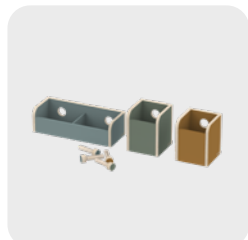

**Craft Caddy Set**  
88-13530-150





COLLECTION OVERVIEW

# IMAGINE

Giving children the freedom to use their imagination  
Dreaming, being curious and empathetic  
Evolving your child's social skills, language skills and integrity



The Shop and Café  
88-14100-132

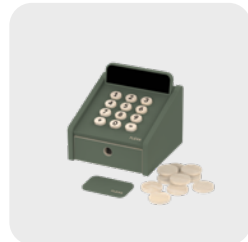

Cash Register  
88-14111-131

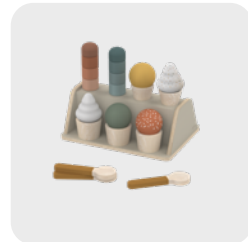

Ice Cream Set  
88-17116-150



Cars  
88-19106-150

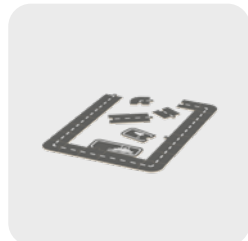

Car Tracks  
88-19102-101



Accessories for Car Tracks  
88-19103-150



Truck and Crane  
88-19104-100



Container Ship  
88-19118-140



The Workbench  
88-15100-130



The Workbench  
88-15100-105



Costume Set  
88-17188-160

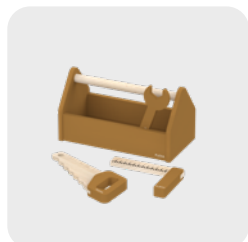

Toolbox  
88-15104-110

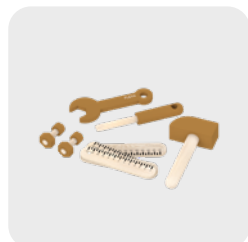

Tool set  
88-15102-110



Toolbox  
88-15104-160

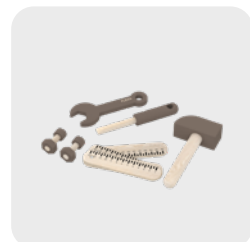

Tool set  
88-15102-160

COLLECTION OVERVIEW

# IMAGINE

Giving children the freedom to use their imagination  
Dreaming, being curious and empathetic  
Evolving your child's social skills, language skills and integrity



The Kitchen  
88-17100-120



The Kitchen  
88-17100-130



The Kitchen  
88-17100-105

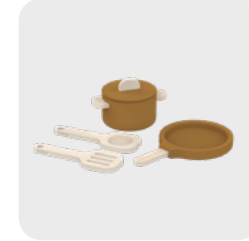

Pot & Pan  
88-17102-110



Pot & Pan  
88-17102-133



Tableware  
88-17104-110



Tableware  
88-17104-133



Groceries  
88-14102-150

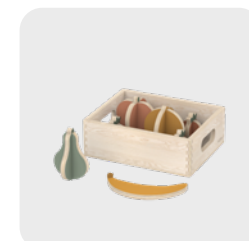

Fruits  
88-14104-150

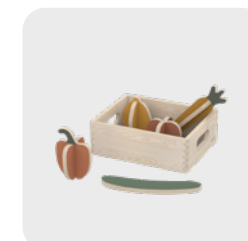

Vegetables  
88-14106-150

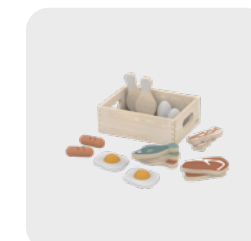

Fish & Meat  
88-14108-150



Pizza  
88-17108-150



Birthday Cake  
88-17113-120



## COLLECTION OVERVIEW

# EXPLORE

**Stimulating children's cognitive development**  
 Focusing, concentrating, reasoning, fine motor skills  
 Developing your child's ability to concentrate and think logically

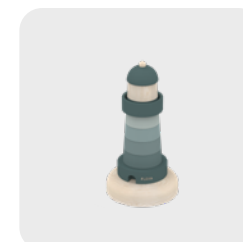

**Lighthouse Stacker**  
88-19202-140

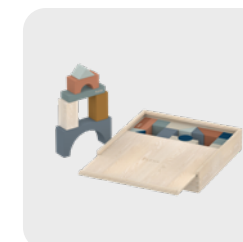

**Wooden Creative Blocks**  
88-12310-150

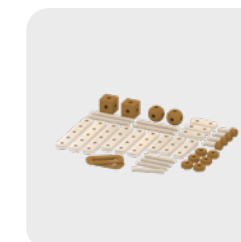

**Construction Set**  
88-15106-110

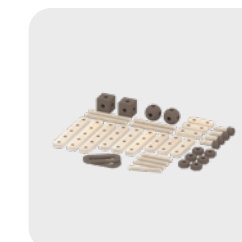

**Construction Set**  
88-15106-160

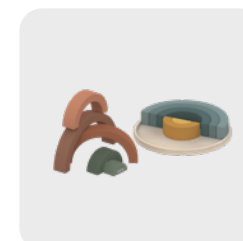

**Rainbow Puzzle**  
88-12312-150

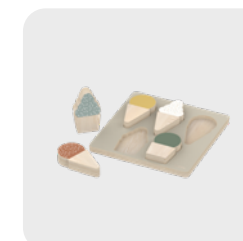

**Ice Cream Puzzle**  
88-17222-100

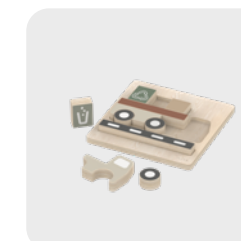

**Truck Puzzle**  
88-19379-100



**The Play Table**  
88-13710-100



**Wooden Memory Game**  
88-12502-150



**Wooden Picture Lotto**  
88-12514-150



**Storage Unit - midi**  
88-13742-100



**Wooden Storage Box Set - mini**  
88-13804-115



# FLEXA Study

## — Try, Learn, Grow

At FLEXA, we want to improve children's lives. We wish to help children grow, nurture their interests, and develop new skills - right from their first big day of school to their teenage years.

We do this by offering a full study collection of ergonomic designs – desks, chairs, and accessories. Clever features such as tilting surfaces and adjustable heights offer good ergonomic support for little students and let them switch position easily, helping them stay focused and energised.

The FLEXA Study collection allows children to TRY, LEARN, and GROW.

### Why FLEXA Study

- ◆ Ergonomic design to give children the best conditions for learning
- ◆ Made to fit the changing needs of growing children
- ◆ Calm colours and timeless finish
- ◆ Created from long-lasting, quality materials
- ◆ Rounded corners for extra comfort and safety







Every FLEXA Study product is especially selected and designed to allow children to TRY, LEARN, and GROW.

## TRY

Encouraging children to challenge themselves.

When children are motivated, inspired and curious, they get new ideas, develop their skills and unfold their creativity.

For children who try their best.

## LEARN

Giving children the best conditions for studying.

When children are ergonomically supported, able to switch position and feeling comfortable, it's easier for them to focus, concentrate and learn.

For children with many questions that need answers.

## GROW

Allowing children to grow both physically and cognitively.

When children develop a skill or learn something new, they grow. Physically, children also grow quickly, and that's why our furniture grows with them.

For children who grow up in the blink of an eye.



### Desks: Woody



- 82-50176-31
  - 82-50176-32
  - 82-50176-33
  - 82-50176-95
- D:70 W:120 H:50-83



- 82-50176-2
  - 82-50176-3
  - 82-50176-40
- D:70 W:120 H:50-83



- Woody - White washed**
- 82-50176-514
  - 82-50176-503
  - 82-50176-502
- D:70 W:120 H:50-83



- Woody - Grey washed**
- 82-50176-514
  - 82-50176-503
  - 82-50176-502
  - 82-50176-504
- D:70 W:120 H:50-83

### Desk: Moby



**Moby - Right up**  
H:58-83 W:120 D:70  
82-50148



**Moby- Left up**  
H:58-83 W:120 D:70  
82-50149



**Moby- Middle Up**  
H:58-83 W:120 D:70  
82-50150

### Desk: Evo



**Evo - Full plate**  
H:58-79 W:120 D:70  
82-50146



**Evo - Split desktop**  
H:58-79 W:120 D:70  
82-50147



**White Desk**  
H:65 L:122 D: 65-75  
82-50081-40







### Desk: Classic



82-50175-2  
82-50175-3  
D:65 W:120 H:70



82-50175-2  
82-50175-3  
D:65 W:120 H:70

### Desk: Popsicle

COLOUR OPTIONS



82-50127-31  
82-50127-32  
82-50127-33  
D:60 W:124 H:74

### Desk Accessories

COLOUR OPTIONS



Desk top stopper  
82-50125  
H:3 W:4 L:35

For Classic Study Desk 82-50116

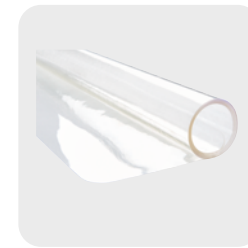

Desk protector  
87-00287  
L:69 D:53



Bag hook  
82-50136

For Evo and Moby



Brush grommet strip  
82-60027

For Woody, Evo and Moby



Desk pad  
82-50137  
82-50138  
82-50140  
H:0,4 W:66 D:43

For Woody, Evo and Moby



EVO - drawer  
82-50142  
82-50143  
82-50145  
H:5 B:64 D:6



Moby - drawer  
82-50141  
H:5, W:75



82-20140-31  
82-20140-32  
82-20140-33  
D:35 W:28 H:8

### Desk Chairs

COLOUR OPTIONS

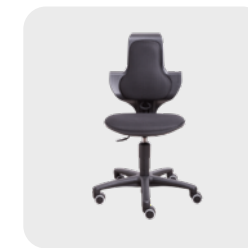

Conversa  
82-10055  
B:60 H:85-99 L:60

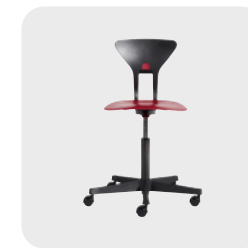

Ray  
82-10033  
82-10034  
82-10035  
82-10037  
B:60 H:78-95 L:60



Novo  
82-10066  
82-10067  
82-10069  
B:58 H:75-100 D:66



Verto  
82-10070  
82-10071  
82-10073  
B:65 H:72-94 D:62



